

Varenummer: 03446140
Beskrivelse: Fluro Heavy Duty Ledleje GE 140 GW-2RS
Hul Ø140
Note: 140

Mål

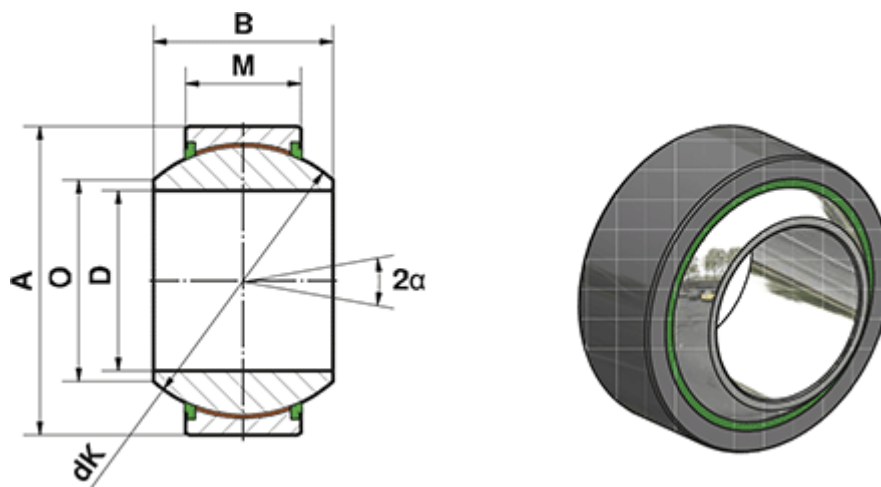

= -	Dynamisk belastning C (kN) = 3840
= -	M = 80
= -	O = 151.9
A = 230	Statisk belastning C0 (kN) = 6400
a (grader) = 16	Vægt (g) = 18600
B = 130	
D = 250	
dK = 200	